

ZGSM-GCD80HB

Introducing a New Premium Experience

150W HID Replacement



Dimming functions are supported by optional
 † Three in One (1-10V DC or PWM Signal or Resistance)
 † Timer - Contact ZGSM for Details

Specifications

Electrical Specifications:

Model No.	ZGSM-GCD80HB
Nominal Wattage	80W
Nominal Voltage	AC 100-240V /277V, 50/60Hz
Maximum Current	AC 0.82A -120V, 0.41A -240V, 0.36A -277V
Operating Temperature	-40 °C to +50 °C
Power Factor (PF)	> 0.9
Driver Efficiency	> 90%

Photometric Specifications:

Lumen Output	7600 lm (+/- 5%)
Photometric Type	60° 90° 110°
CRI	> 70 CRI
CCT	<div style="display: flex; gap: 10px;"> <div style="border: 1px solid black; border-radius: 50%; padding: 2px 5px; background-color: #f9a825; color: white;">4000K</div> <div style="border: 1px solid black; border-radius: 50%; padding: 2px 5px; background-color: #f9a825; color: white;">5000K</div> <div style="border: 1px solid black; border-radius: 50%; padding: 2px 5px; background-color: #f9a825; color: white;">5700K</div> </div>

Mechanical Specifications:

Ratings	IP66, IK10
Lumen Maintenance	> 60,000 hours -L70(9K), @25 °C (77 °F)
Heat Radiator	Anodized Aluminum
Lens	PC
Fixture Dimension	239 x270 x165 mm 9.4 x10.6 x6.5 inches
Fixture Weight	3.5 kg /7.7 lbs

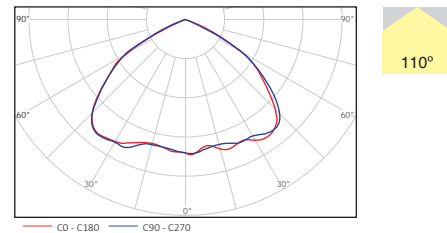
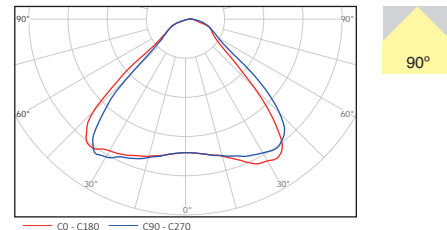
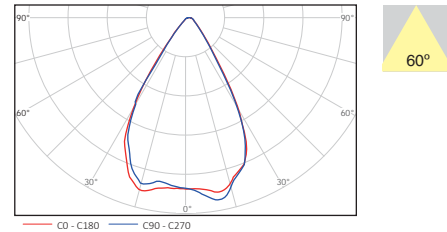
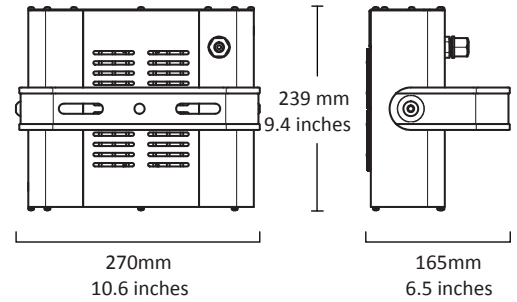

Packing Type

1 unit(s) /ctn.

Packing Dimension

355 x370 x200 mm
14.0 x14.6 x7.9 inches

Packing Weight

4.3 kg /9.5 lbs



CE RoHS CB

www.zgsm-china.com

